

Model: PCX2000

Part number: 90063285

Year: 2022

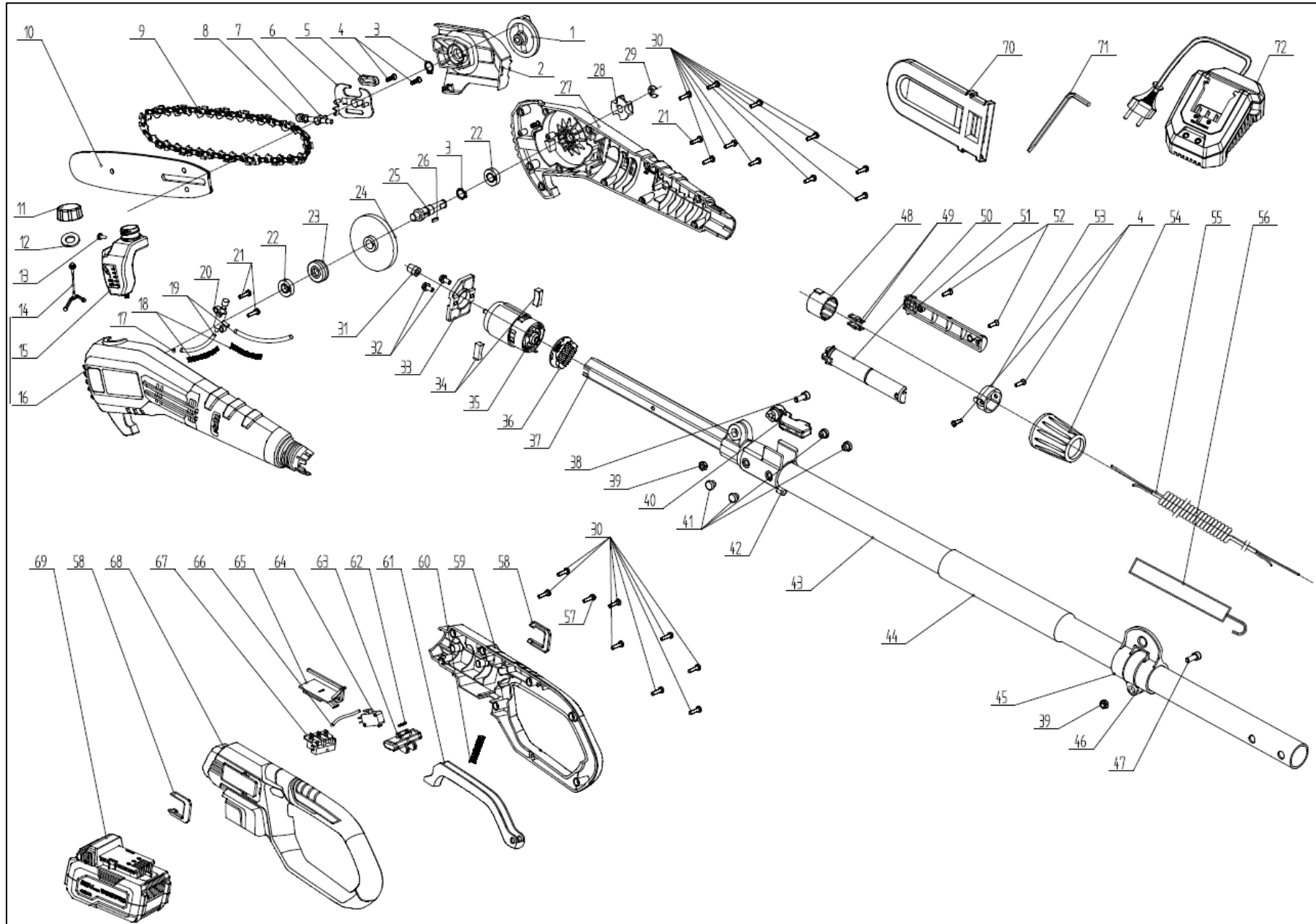

POS	QTY	PARTNUMBER	BESKRIVELSE	DESCRIPTION
1	1	448626	LÅSE HÅNDTAG	LOCK KNOB
2	1	448627	SIDEDÆKSEL	CHAIN BAR COVER
3	2	448628	LÅSERING	EXTERNAL CIRCLIP
4	4	448615	SKRUE	CROSS RECESSED COUNTERSUNK HEAD TAPPING
5	1	448629	PAKNING	OIL OUTLET SEALING RING
6	1	448630	JUSTERINGSPLADE	ADJUSTING PRESSURE PLATE
7	1	448631	JUSTERSTYKKE	ADJUSTING HEAD
8	1	448632	KÆDEAKSEL	CHAIN PRESSURE AXLE
9	1	441889	SAVKÆDE OREGON 90PX033X	SAW CHAIN
10	1	448633	SVÆRD 8" 080SDEA041	BAR 8"
11	1	448634	SKRUELÅG	CAN TOP
12	1	448635	PAKNING	SEALING RING
13	1	448636	UDLUFTNINGSVENTIL	BREATHER VALVE
14	1	448637	HOLDER FOR SKRUELÅG	OIL RAPE
15	1	448638	OLIETANK	OILER
16	1	448639	MOTORHUS VENSTRE	LEFT CASING
17	1	448640	KLEMME	CLAMP
18	2	448641	FJEDER OLIESLANGE	OIL TUBE SPRING
19	2	448642	OLIESLANGE	OIL TUBE
20	1	448643	FJEDER OLIESLANGE	OIL TUBE SPRING
21	3	448644	SKRUE	SELF-TAPPING SCREW PAN HEAD TORX
22	2	448645	LEJE	BEARING
23	1	448646	OLIEPUMPE	OIL PUMP TURBINE
24	1	448647	STORT GEAR	BIG GEAR
25	1	448648	AKSEL	SHAFT
26	1	448649	NØGLE	KEY
27	1	448650	MOTORHUS HØJRE	RIGHT HOUSING
28	1	448651	TANDHJUL	SPROCKET
29	1	448652	HESTESKORING	E CHECK RING
30	18	448526	SKRUE	INNER PLUM PAN HEAD SELF - TAPPING SCREW
31	1	448653	LILLE GEAR	SMALL GEAR
32	2	448654	BOLT	CROSS GROOVED DISC HEAD THREE COMBINATIO
33	1	448655	STØTTEPLADE	CENTRAL SUPPORT
34	2	448656	VIBRATIONSDÆMPER	ANTI-VIBRATION PAD
35	1	448657	MOTOR	775 MOTOR
36	1	448658	PLADE	ANTI-INTERFERENCE PCB ASSEMBLY
37	1	448599	ALU RØR	HEXAGONAL ALUMINUM TUBE
38	1	448600	SKRUE	HEXAGON SOCKET SOCKET HEAD MACHINE SCREW
39	2	448601	MØTRIK	HEXAGON CHECK NUT
40	1	448602	LÅSEBESLAG	LOCKING WRENCH
41	4	448603	RØRSTIFT	TUBE PIN
42	1	448604	KLEMMEBESLAG	OLOCK SLEEVE
43	1	448605	RØR	GLASS FIBER TUBE

POS	QTY	PARTNUMBER	BESKRIVELSE	DESCRIPTION
44	1	448606	SOFTGRIP	SPONGE CASING
45	1	448607	SELEKROG	LINK SET
46	1	448608	BESLAG	LOCATING SLEEVE
47	1	448609	SKRUE	HEXAGON SOCKET SOCKET HEAD MACHINE SCREW
48	1	448595	STIK	SOCKET
49	2	448610	HUNSTIK	POWER FEMALE SOCKET
50	1	448611	POLSTIK VENSTRE	LEFT POLE PLUG
51	1	448613	POLSTIK HØJRE	RIGHT POLE PLUG
52	2	448659	SKRUE	SELF-TAPPING SCREW PAN HEAD TORX
53	1	448614	STOPKLEMME	STOP BLOCK
54	1	448616	LÅSEKRAVE	COVER OF LOCKING SLEEVE
55	1	448617	FJEDER LEDNING	SPRING WIRE
56	1	448618	REM	BELT
57	1	448619	SKRUE	INNER PLUM PAN HEAD SELF - TAPPING SCREW
58	2	448514	PYNTELISTE	U-SHAPED DECORATIVE PIECES
59	1	448620	HÅNDTAG HØJRE	RIGHT HANDLE
60	1	448621	FJEDER	BUTTON SPRING
61	1	448622	UDLØSERKNAP	SWITCH TRIGGER
62	1	448517	LÅSEFJEDER	SWITCH SELF-LOCKING SPRING
63	1	448516	LÅSEKNAP	ANTI-SELF-LOCKING BUTTON
64	1	448531	KONTAKT	MICRO SWITCH
65	1	448623	PRINTPLADE	20V DISCHARGE BOARD ASSEMBLY
66	1	448624	LEDNING	INTERNAL WIRE
67	1	448520	STIK	SOCKET
68	1	448625	HÅNDTAG VENSTRE	LEFT HANDLE
69	1	90063245	20V 2.0AH BATTERI	
70	1	432966	SVÆRDBESKYTTER 8"	BLADE COVER
71	1	448660	JUSTERINGSNØGLE	ADJUSTING SPANNER
72	1	90063242	HURTIG LADER 20V	QUICK CHARGER