

Model: LBX2000

Part Number: 90063283

Year: 2022

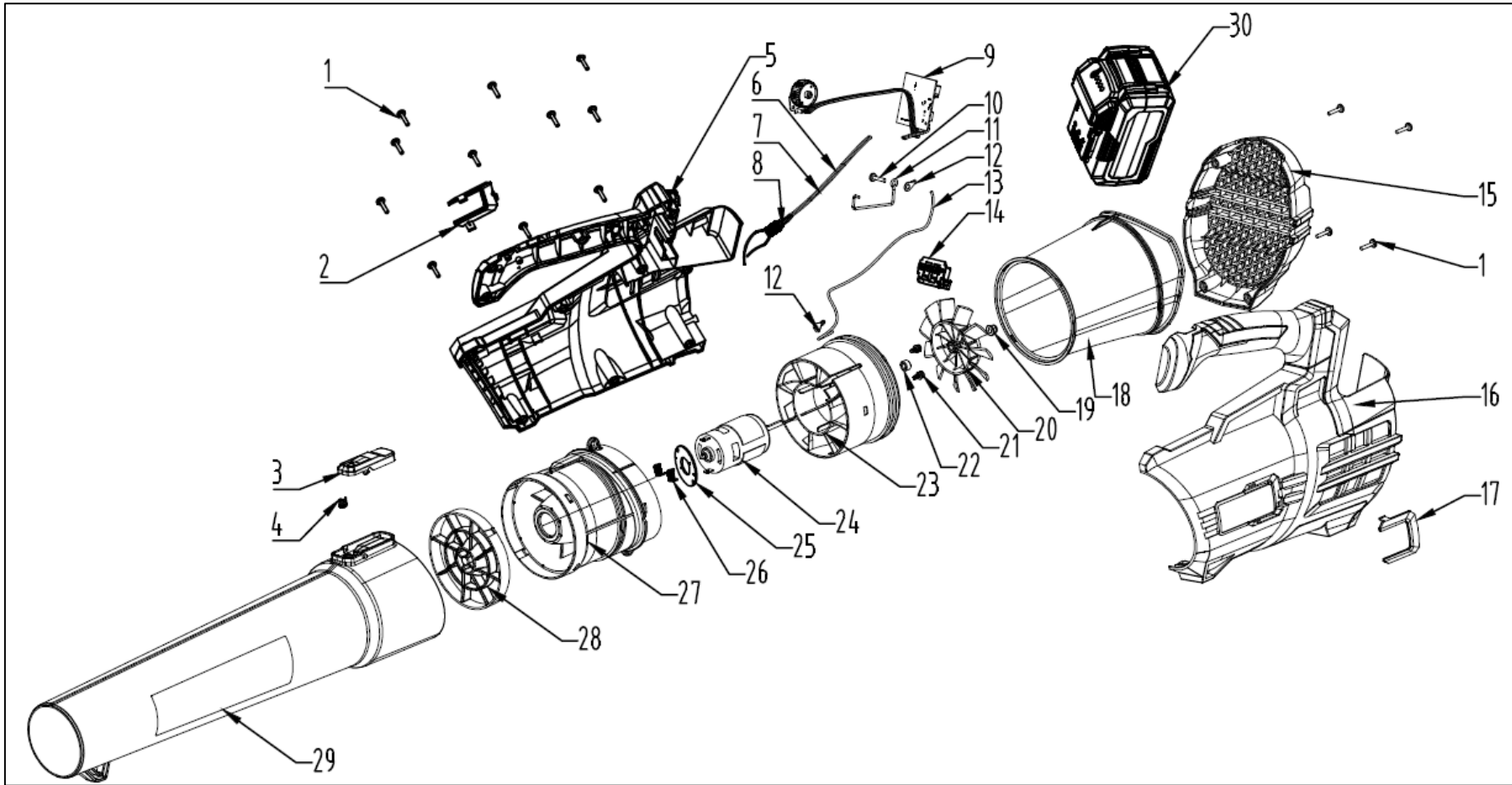

POS	QTY	PARTNUMBER	BESKRIVELSE	DESCRIPTION
1	15	448526	SKRUE	INNER PLUM PAN HEAD SELF - TAPPING SCREW
2	1	448560	PYNTELISTE	RIGHT DECORATIVE COVER
3	1	448561	LÅSEKNAP BLÆSERØR	BLAST PIPE
4	1	448562	LÅSEMØTRIK	LOCKNUT OF BLAST PIPE
5	1	448563	MOTORHUS HØJRE	RIGHT HOUSING
6	1	448564	LEDNING	INTERNAL WIRE
7	1	448565	LEDNING	INTERNAL WIRE
8	1	448566	STIK	INDUCTANCE
9	1	448567	PRINTPLADE	DISCHARGE PLATE + SPEED REGULATING PLATE
10	1	448568	SKRUE	SELF-TAPPING SCREW PAN HEAD TORX
11	1	448569	ANTISTATISK LEDNING	ANTISTATIC WIRE
12	2	448570	PLADE	LUG PLATE
13	1	448571	LEDNING	INTERNAL WIRE
14	1	448520	STIK	SOCKET
15	1	448572	LUFTINDTAG	SUCTION CANAL
16	1	448573	MOTORHUS VENSTRE	LEFT CASING
17	1	448574	PYNTELISTE VENSTRE	LEFT DECORATIVE COVER
18	1	448575	DÆKSEL	SLIP RING
19	1	448576	LÅSEMØTRIK M5	M5 SELF-LOCK NUT
20	1	448577	BLÆSER	BLADE FAN
21	2	448550	SKRUE	CROSS RECESSED TRIPLE SET SCREWS
22	1	448578	AKSEL MUFFE	AXLE SLEEVE
23	1	448579	MOTOR HOLDER	MOTOR SETTING
24	1	448580	MOTOR	"775 BRUSH MOTOR+ DIAMAGNETIC COVER"
25	1	448581	SKIVE	ANTI-INTERFERENCE PCB
26	2	448582	MAGNET INDUKTOR	MAGNET INDUCTOR
27	1	448583	RØR SAMLESTYKKE	DIFFUSER
28	1	448584	BLÆSER FOR ENRETTER	OUTLET HOUSING
29	1	448585	BLÆSERØR	WIND TUBE
30	1	90063246	20V 4.0AH BATTERI	