

Model: Razor 3300Li

Part Number: 90063158

Year: 2020

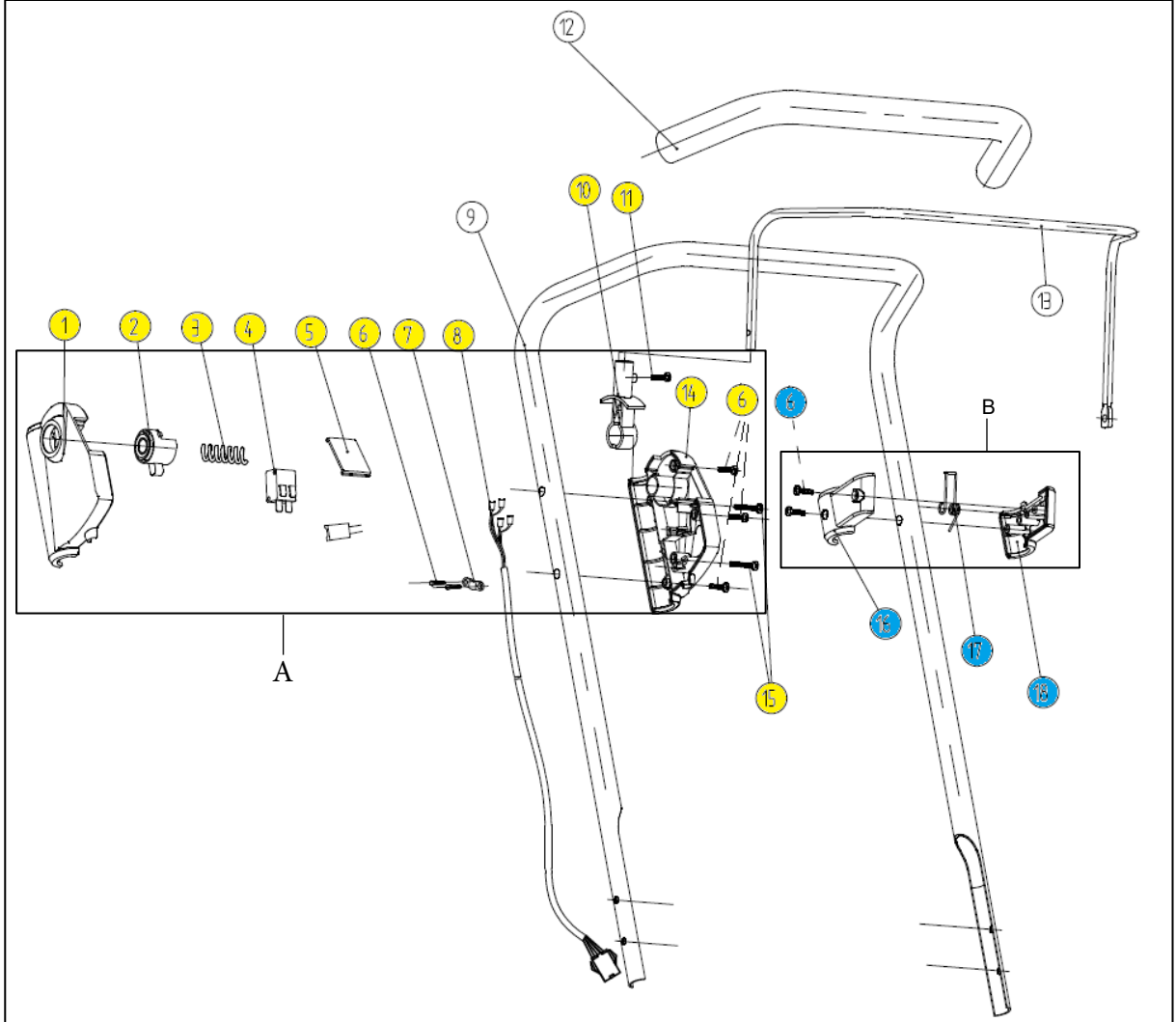

POS	QTY	PARTNUMBER	BESKRIVELSE	DESCRIPTION
1	1	443677	BOKS FOR KONTAKT ØVRE	SWITCH BOX UP-COVER
2	1	443678	KNAP FOR KONTAKT	SAFETY SWITCH BUTTON
3	1	443679	FJEDER	BUTTON SPRING
4	1	443680	KONTAKT	SWITCH
5	1	443681	LÅSE HÆTTE FOR KONTAKT	SWITCH BOX BLANKING CAP
6	5	443682	SKRUE SELVSKÆRENDE ST4X16	SELF-TAPPING SCREW ST4X16
7	1	443683	KABEL STRAMMER	CABLE TENSION DISC
8	1	443684	KABEL	CABLE
9		443694	HÅNDTAG ØVRE	UP HANDLE
10	1	443685	TRIGGER	TRIGGER SPACING LUMP
11	1	443686	SKRUE SELVSKÆRENDE ST4X12	SELF-TAPPING SCREW ST4X12
12		443695	SOFTGRIP	SPONGE
13		443696	BØJLE FOR STOP	TRIGGER
14	1	443687	SKÆRM FOR KONTAKT NEDRE	SWITCH BOX UNDER COVER
15	2	443688	SKRUE SELVSKÆRENDE ST4X20	SELF-TAPPING SCREW ST4X20
16		443690	SKÆRM FOR TRIGGER ØVRE	TRIGGER UP COVER
17		443691	FJEDER FOR TRIGGER	TRIGGER TORSIONAL SPRING
18		443692	SKÆRM FOR TRIGGER NEDRE	TRIGGER UNDER COVER
A	1	443689	KONTAKT KOMPLET	SWITCH BOX ASSY
B	1	443693	SKÆRM FOR TRIGGER KOMPLET	COVER ASSY

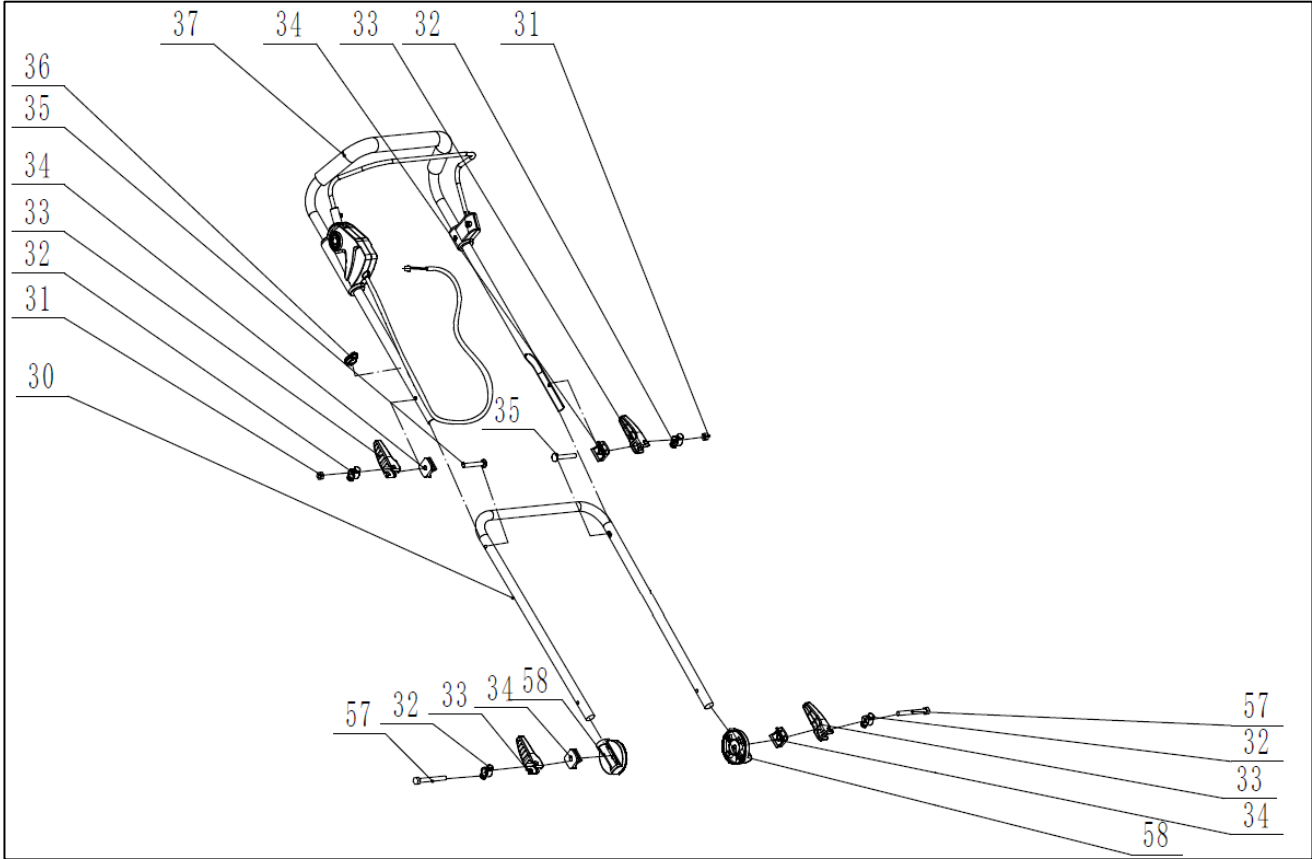

POS	QTY	PARTNUMBER	BESKRIVELSE	DESCRIPTION
30	1	443697	HÅNDTAG NEDRE	UNDER HANDLE
31	4	443698	MØTRIK M8	NUTS M8
32	4	443699	SKIVE	NUTS KNOT
33	4	443700	LÅSEKNOP	KNOB
34	4	443701	HOLDER	GASKET
35	2	443702	BOLT M8X50	STEP BOLT M8X50
36	2	443703	KABELHOLDER	CABLE CLAMP
57	2	443704	BOLT M8X75	OUTER HEXAGON BOLT M8X75
58	2	443705	ØVERSTE SAMLEDÆKSEL	UPPER CONNECT COVER

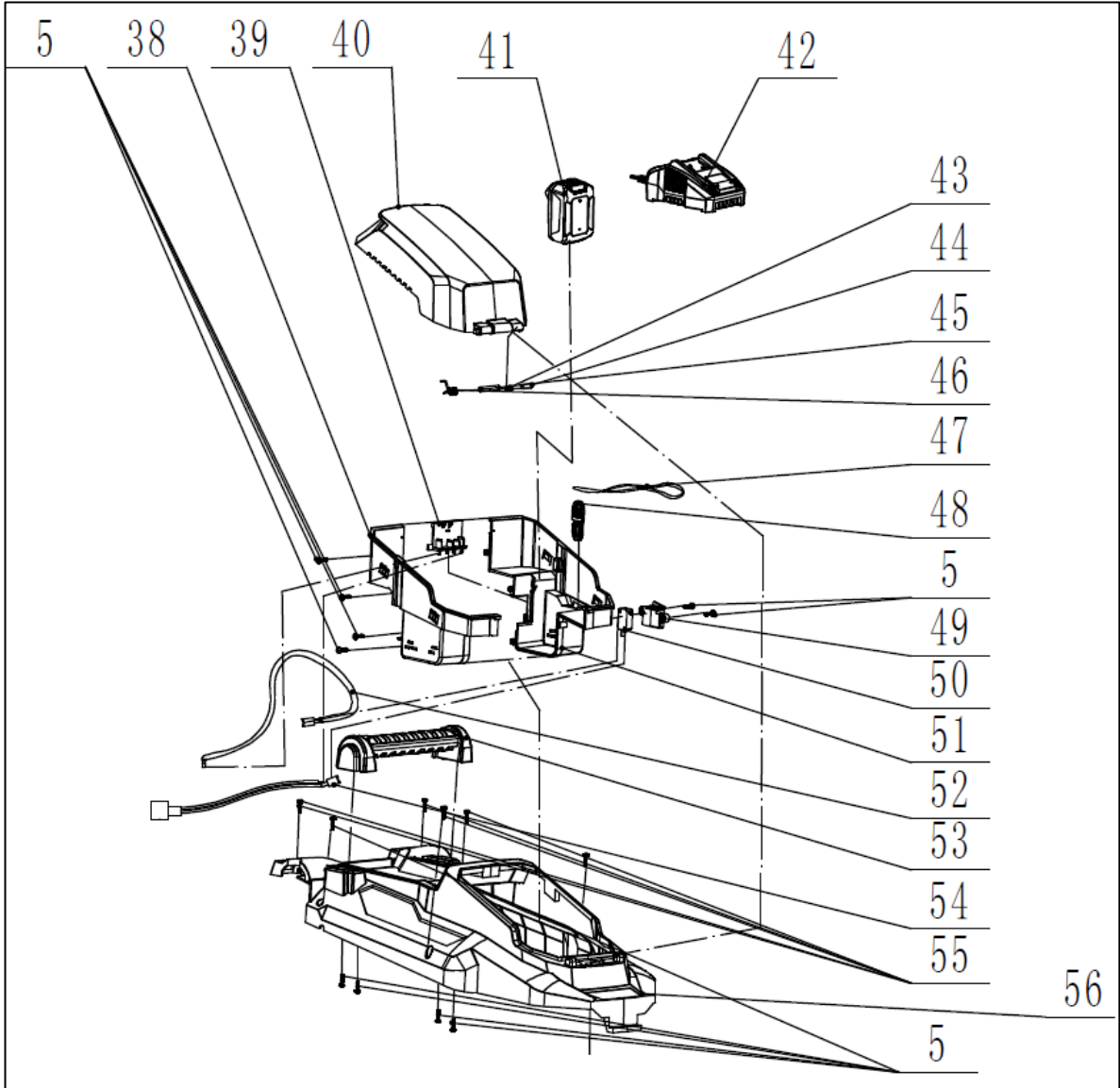

POS	QTY	PARTNUMBER	BESKRIVELSE	DESCRIPTION
5	10	443706	SELSKÆRENDE SKRUE ST4.2X14	SELF-TAPPING SCREW ST4.2X14
38	1	443707	BATTERIKASSE HØJRE	RIGHT STOREHOUSE FOR BATTERY PACK
39	1	443708	BATTERIKONSOL	ILLUSTRATION BASE
40	1	443709	BATTERICOVER	STOREHOUSE COVER
41	1	443547	BATTERI 18V/3.0AH	
42	1	443711	LADER 18V	CHARGER
43	1	443712	FJEDER Ø5.4X18	SPRING
44	1	443713	STIFT KORT Ø6X16	SHORT PIN
45	1	443714	STIFT LANG Ø6X35	LONG PIN
46	1	443715	FJEDER FOR BATTERI COVER	STOREHOUSE COVER SPRING
47	1	443716	REM FOR SIKKERHEDSNØGLE	SAFE KEY BELT
48	1	443717	SIKKERHEDSNØGLE	SAFE KEY
49	1	443718	KONTAKTPLADE	SAFETY SWITCH PRESSING PLATE
50	1	443719	MIKRO SWITCH 20A	MICRO SWITCH
51	1	443720	BATTERIKASSE VENSTRE	LEFT STOREHOUSE FOR BATTERY PACK
52	1	443721	+ LEDNING FOR KONTAKT	SWITCH POSITIVE WIRE
53	1	443722	BÆREHÅNDTAG	CARRY HANDLE
54	1	443723	KABEL	CABLE
55	5	443688	SKRUE SELVSKÆRENDE ST4X20	SELF-TAPPING SCREW ST4X20
56	1	443724	DÆKSEL	UP-COVER

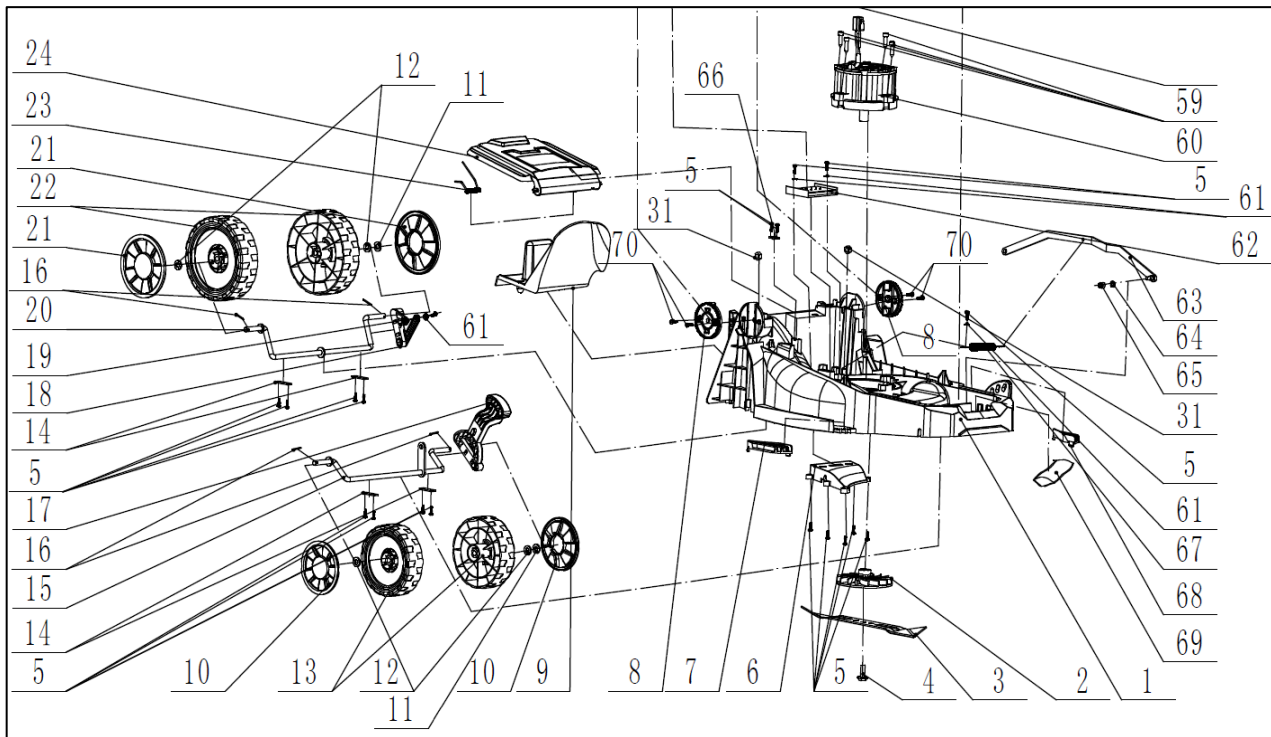

POS	QTY	PARTNUMBER	BESKRIVELSE	DESCRIPTION
1	1	443725	KLIPPESKJOLD	CHASSIS
2	1	443726	BLÆSEHJUL	FAN BLADE
3	1	443727	KNIV	BLADE
4	1	443728	KNIVBOLT M10X23	BLADE SCREW
5	18	443706	SELSKÆRENDE SKRUE ST4.2X14	SELF-TAPPING SCREW ST4.2X14
6	1	443729	DÆKSEL	GRASS LEAD BOARD
7	1	443730	COVER VENSTRE	LEFT DECORATE BLOCK
8	2	443731	NEDERSTE STYRHOLDER VENSTRE	UNDER HANDLE COVER VENSTRE
9	1	443732	BIOPLUG	GRASS BLOCKER
10	2	443733	HJULKAPSEL 5,5"	"5.5" WHEEL COVER"
11	4	443734	SKIVE Ø10.5Ø20X1,5	FLAT GASKET
12	2	443735	SKIVE Ø10.5Ø20X1,5	ADJUST GASKET
13	2	443736	FORHJUL 5,5"	"5.5" FRONT WHEEL"
14	4	443737	TRYKPLADE FOR FORAKSEL	FRONT WHEEL AXLE PRESSING PLATE
15	1	443738	FORAKSEL	FRONT WHEEL AXLE SET
16	4	443739	NÅLESPLIT	SPLIT PIN
17	1	443740	HØJDEJUSTERING	HEIGHT ADJUST HANDLE
18	1	443741	ENDESTYKKE FOR AKSEL	REAR-GUARD HOLDER
19	1	443742	SKRUE ST4.2X10	CROSS RECESS PAN HEAD SCREW ST4.2X10
20	1	443743	BAGAKSEL	REAR WHEEL AXLE SET
21	2	443744	HJULKAPSEL 6,5"	"6.5" WHEEL COVER"
22	2	443745	BAGHJUL 6,5"	"6.5" REAR WHEEL"
23	1	443746	FJEDER	REAR COVER TORSIONAL SPRING
24	1	443747	UDKASTERKLAP	REAR COVER
31	4	443698	MØTRIK M8	NUTS M8
59	4	443748	SKRUE SELVSKÆRENDE ST6.3X25	HEXAGON SOCKET CYLINDRICAL HEAD SELF- TAP
60	1	443749	MOTOR 18V	MOTOR
61	4	443750	PAKNING	FLAT GASKET 5
62	1	443751	STYRBOKS	CONTROLLER
63	1	443752	HØJDEJUSTERING GREB	HEIGHT ADJUST CONNECTING ROD
64	1	443753	PAKNING Ø5XØ16X1,2	FLAT GASKET 6
65	1	443754	MØTRIK M6	NUTS M6
66	1	443755	SPÆNDESKIVE	TENSION DISC
67	1	443756	FJEDER FOR HØJDEJUSTERING	HEIGHT AGJUST SPRING
68	1	443757	COVER HØJRE	RIGHT DECORATE BLOCK
69	1	443758	BALANCEAKSEL	BALANCE SAND BAG
70	4	443759	SKRUE SELVSKÆRENDE ST5X16	"SELF-TAPPING SCREW ST5X16"

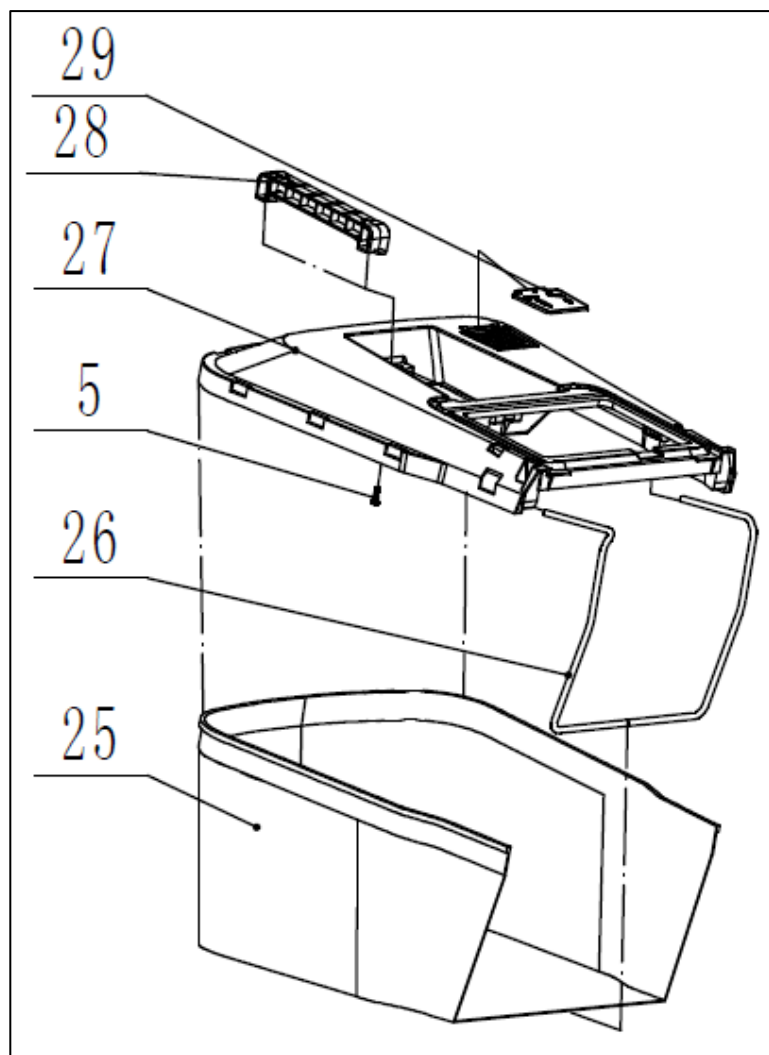

POS	QTY	PARTNUMBER	BESKRIVELSE	DESCRIPTION
5	1	443706	SELSKÆRENDE SKRUE ST4.2X14	SELF-TAPPING SCREW ST4.2X14
25		443760	OPSAMLERPOSE	UNDER COLLECTION BAG
26		443761	BØJLE	GRASS BAG FRAME
27	1	443762	OPSAMLER ØVERST	UPPER COLLECTION BAG
28	1	443763	HÅNDTAG FOR OPSALMER	COLLECTION BAG CARRY HANDLE
29	1	443764	INDIKATOR FOR FYLDT OPSAMLER	FULL GRASS INDICATE COVER