

Model: PHX2000

Part Number: 90063284

Year: 2022

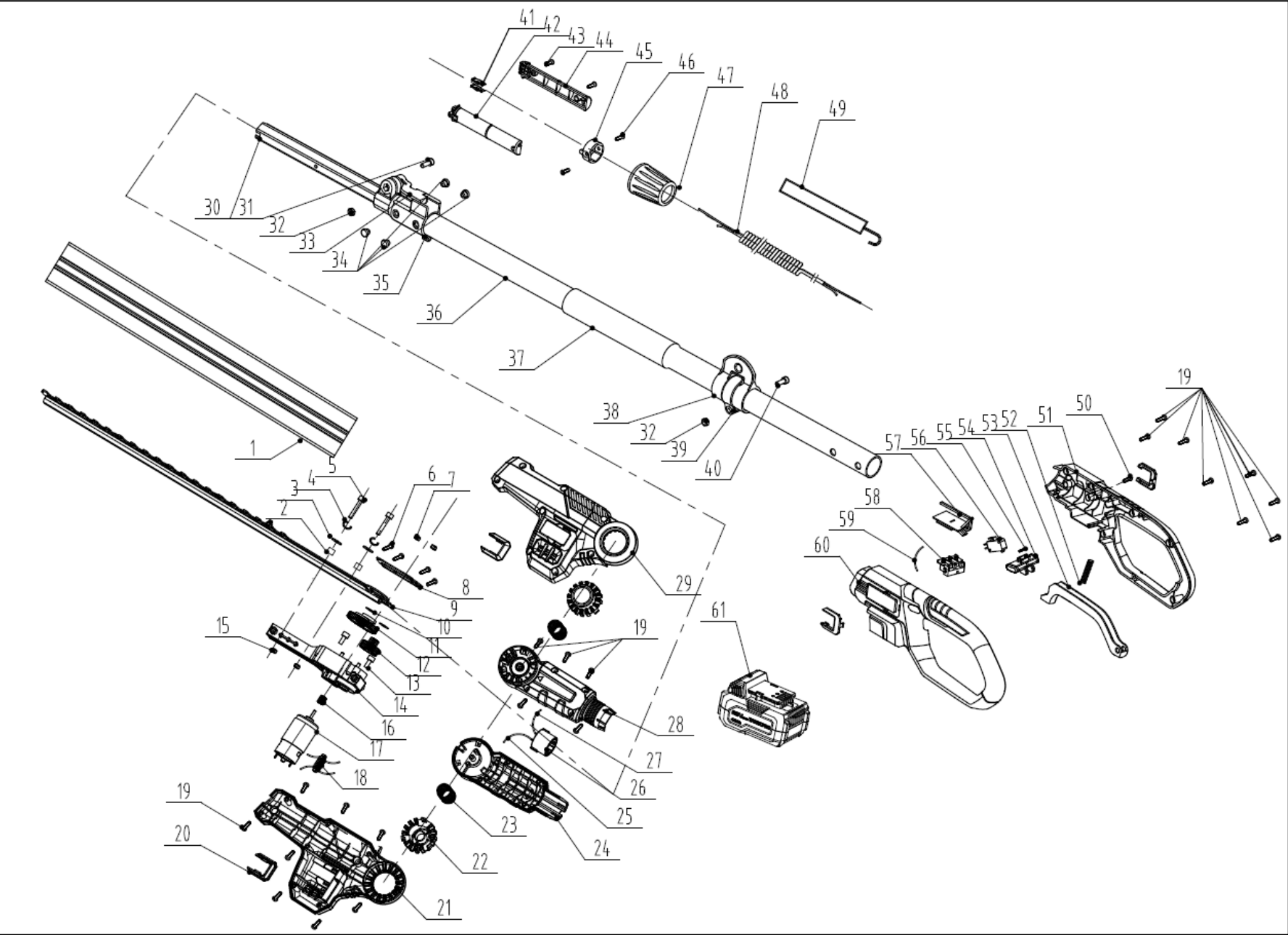

POS	QTY	PARTNUMBER	BESKRIVELSE	DESCRIPTION
1	1	448586	KNIVBESKYTTER	BLADE COVER
2	2	448587	BØS	SLIDER
3	2	448490	SKIVE	?15*?6.2*?0.3 FLAT WASHERS
4	2	448489	SKIVE Ø5	Ø5 SPRING WASHER
5	2	448488	SKRUE	HEXAGON SOCKET SOCKET HEAD MACHINE SCREW
6	4	448588	SKRUE	INNER PLUM PAN HEAD SELF - TAPPING SCREW
7	2	448494	LÅSEMØTRIK M4	HEXAGON LOCKNUT M4
8	1	448495	BUNDPLADE	CENTER BRACKET PRESS PLATE
9	1	448589	KNIV	410 BLADE ASSEMBLY
10	2	448499	SKIVE	?15*?6.2*?0.3 FLAT WASHERS
11	1	448497	TANDHJUL	ECCENTRIC GEAR
12	1	448498	GEAR	DUPLEX GEAR
13	2	448501	KRYDSPIND	CROSS RECESSED SMALL PAN HEAD TRIPLE SET
14	1	448502	KNIVBESLAG	CENTER BEARING BRACKET
15	2	448503	LÅSEMØTRIK M5	HEXAGON LOCKNUT M5
16	1	448500	TANDHJUL	MOTOR PINION
17	1	448504	MOTOR	590 MOTOR
18	1	448566	STIK	INDUCTANCE
19	21	448526	SKRUE	INNER PLUM PAN HEAD SELF - TAPPING SCREW
20	4	448514	PYNTELISTE	U-SHAPED DECORATIVE PIECES
21	1	448590	GEARHUS VENSTRE	LEFT HOUSING
22	2	448591	KNAP	BUTTON
23	2	448592	FJEDER	BUTTON SPRING
24	1	448593	ROTATIONSARM VENSTRE	LEFT ROTATING ARM
25	1	448594	LEDNING	INTERNAL WIRE
26	1	448595	STIK	SOCKET
27	1	448596	LEDNING	INTERNAL WIRE
28	1	448597	ROTATIONSARM HØJRE	RIGHT ROTATING ARM
29	1	448598	GEARHUS HØJRE	RIGHT HOUSING
30	1	448599	ALU RØR	HEXAGONAL ALUMINUM TUBE
31	1	448600	SKRUE	HEXAGON SOCKET SOCKET HEAD MACHINE SCREW
32	1	448601	MØTRIK	HEXAGON CHECK NUT
33	1	448602	LÅSEBESLAG	LOCKING WRENCH
34	4	448603	RØRSTIFT	TUBE PIN
35	1	448604	KLEMMEBESLAG	OLOCK SLEEVE
36	1	448605	RØR	GLASS FIBER TUBE
37	1	448606	SOFTGRIP	SPONGE CASING
38	1	448607	SELEKROG	LINK SET
39	1	448608	BESLAG	LOCATING SLEEVE
40	1	448609	SKRUE	HEXAGON SOCKET SOCKET HEAD MACHINE SCREW
41	2	448610	HUNSTIK	POWER FEMALE SOCKET
42	1	448611	POLSTIK VENSTRE	LEFT POLE PLUG
43	2	448612	SKRUE	INNER PLUM PAN HEAD SELF - TAPPING SCREW

POS	QTY	PARTNUMBER	BESKRIVELSE	DESCRIPTION
44	1	448613	POLSTIK HØJRE	RIGHT POLE PLUG
45	1	448614	STOPKLEMME	STOP BLOCK
46	2	448615	SKRUE	CROSS RECESSED COUNTERSUNK HEAD TAPPING
47	1	448616	LÅSEKRAVE	COVER OF LOCKING SLEEVE
48	1	448617	FJEDER LEDNING	SPRING WIRE
49	1	448618	REM	BELT
50	1	448619	SKRUE	INNER PLUM PAN HEAD SELF - TAPPING SCREW
51	1	448620	HÅNDTAG HØJRE	RIGHT HANDLE
52	1	448621	FJEDER	BUTTON SPRING
53	1	448622	UDLØSERKNAP	SWITCH TRIGGER
54	1	448516	LÅSEKNAP	ANTI-SELF-LOCKING BUTTON
55	1	448517	LÅSEFJEDER	SWITCH SELF-LOCKING SPRING
56	1	448531	KONTAKT	MICRO SWITCH
57	1	448623	PRINTPLADE	20V DISCHARGE BOARD ASSEMBLY
58	1	448520	STIK	SOCKET
59	1	448624	LEDNING	INTERNAL WIRE
60	1	448625	HÅNDTAG VENSTRE	LEFT HANDLE
61	1	90063245	20V 2.0AH BATTERI	